

Bandings

All Parts May
Be Scaled
Up Or Down

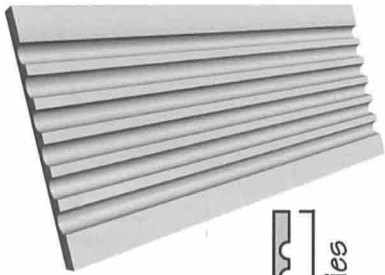

B-1

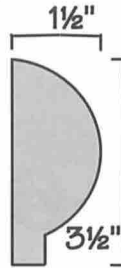
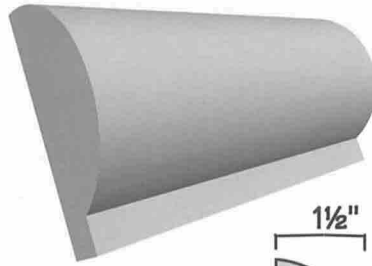

B-2

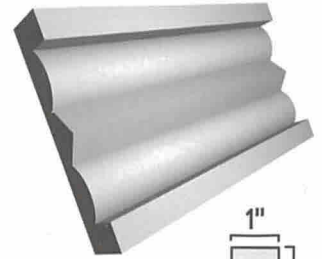

B-3

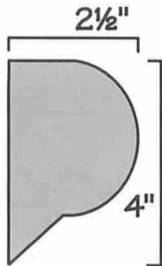
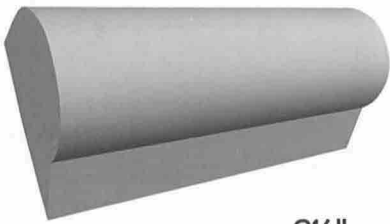

B-4

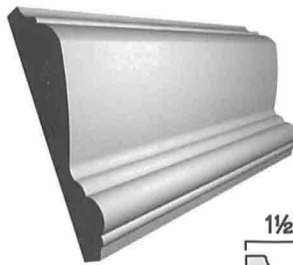

B-5

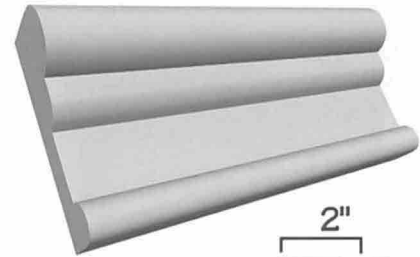

B-6

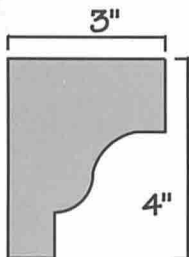
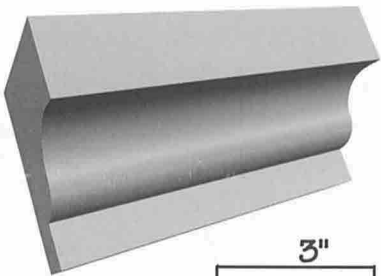

B-7

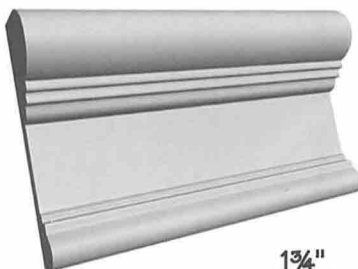

B-8



B-9

All Parts May
Be Scaled
Up Or Down

Bandings

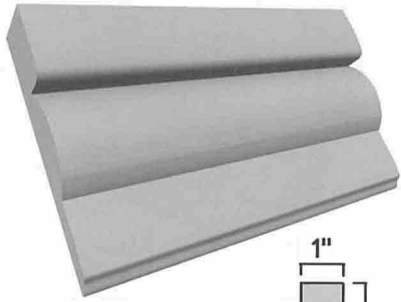

B-10

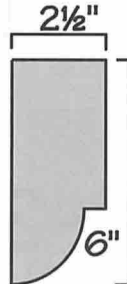
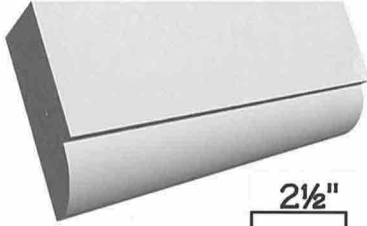

B-11

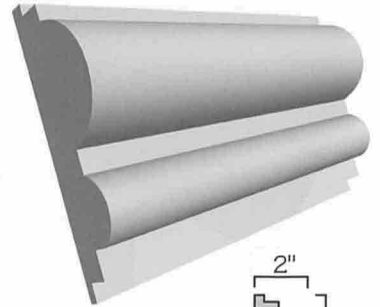

B-12

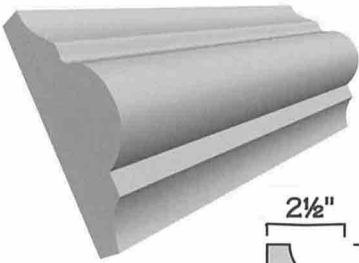

B-13

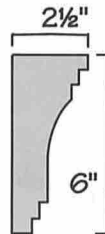
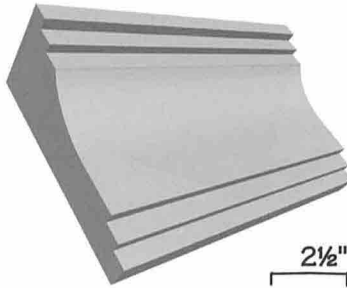

B-14

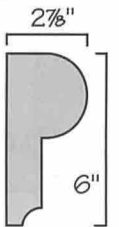
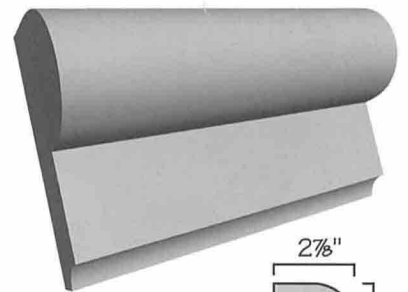

B-15

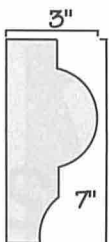
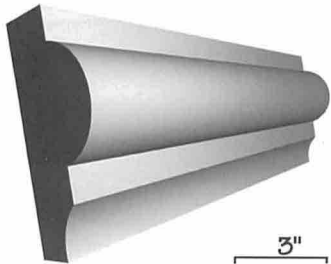

B-16

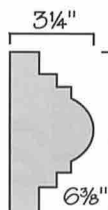
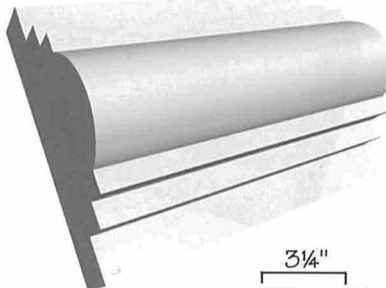

B-17

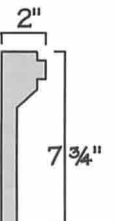
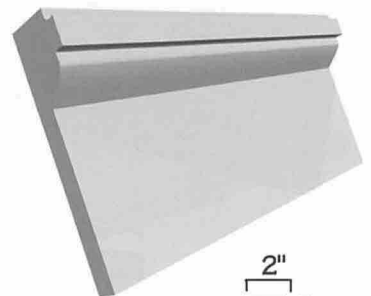

B-18

Bandings

All Parts May
Be Scaled
Up Or Down

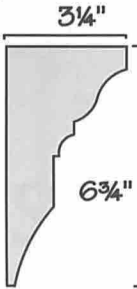
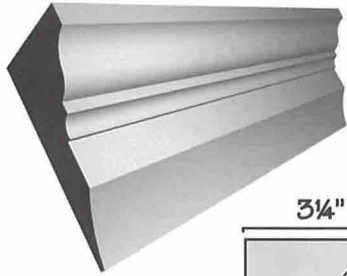

B-19

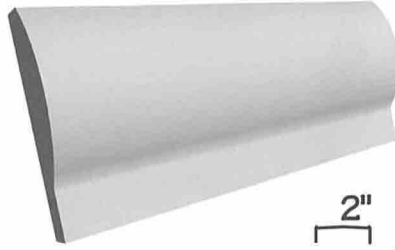

B-20

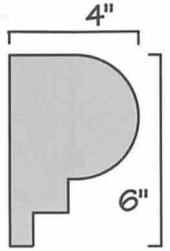
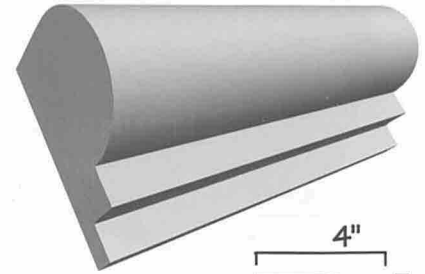

B-21

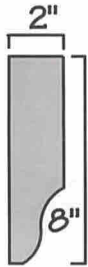
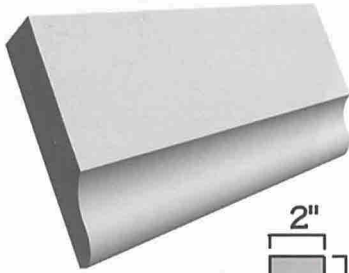

B-22

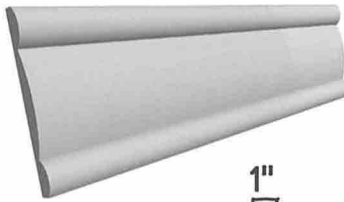

B-23

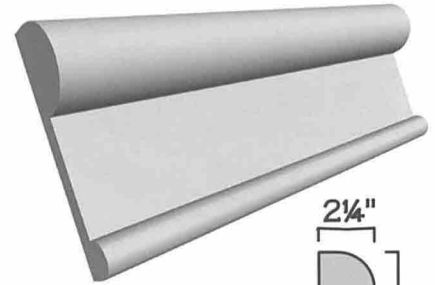

B-24

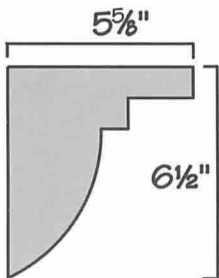
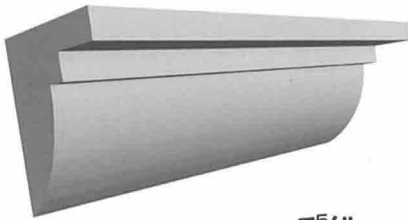

B-25

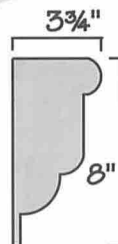
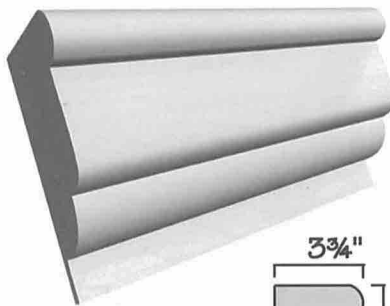

B-26

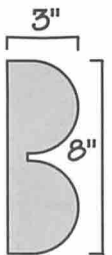
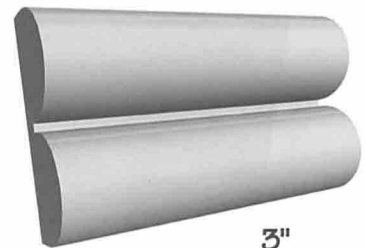

B-27

